

Article number: 20475B8B8MT

Description: E+G Two-way clamp mounting - GN 475-B8-B8-MT

Measures

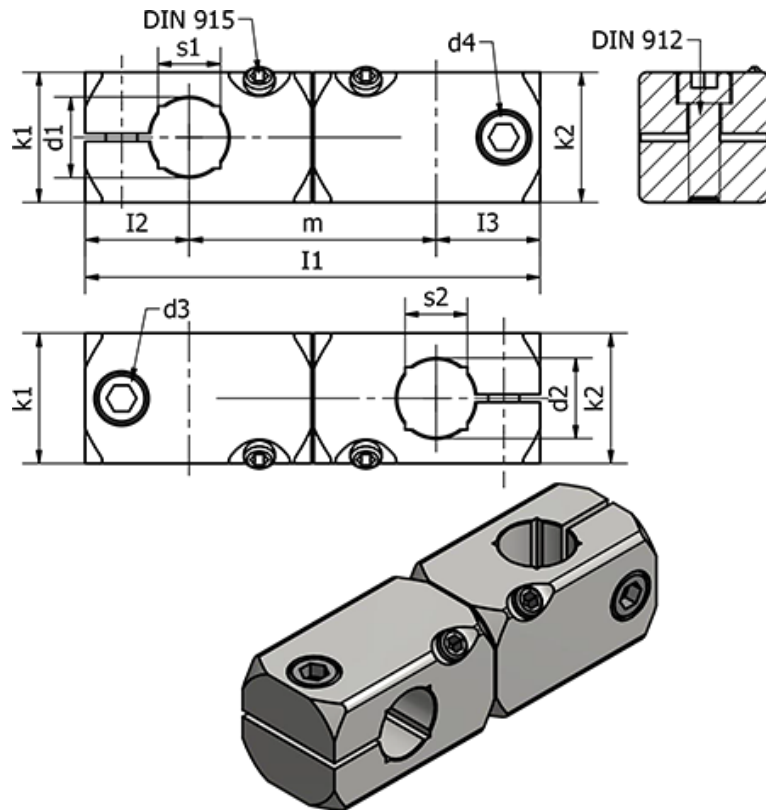

Clamping kit for d3 = GN 511-M4-16

Clamping kit for d4 = GN 511-M4-16

d1 = 8

d2 = 8

d3 = M4

d4 = M4

I1 = 52.5

I2 = 13

I3 = 13

k = 16

k2 = 16

m = 26.5

s1 = -

s2 = -

Weight (g) = 34